

Art. 11601

# CARGO

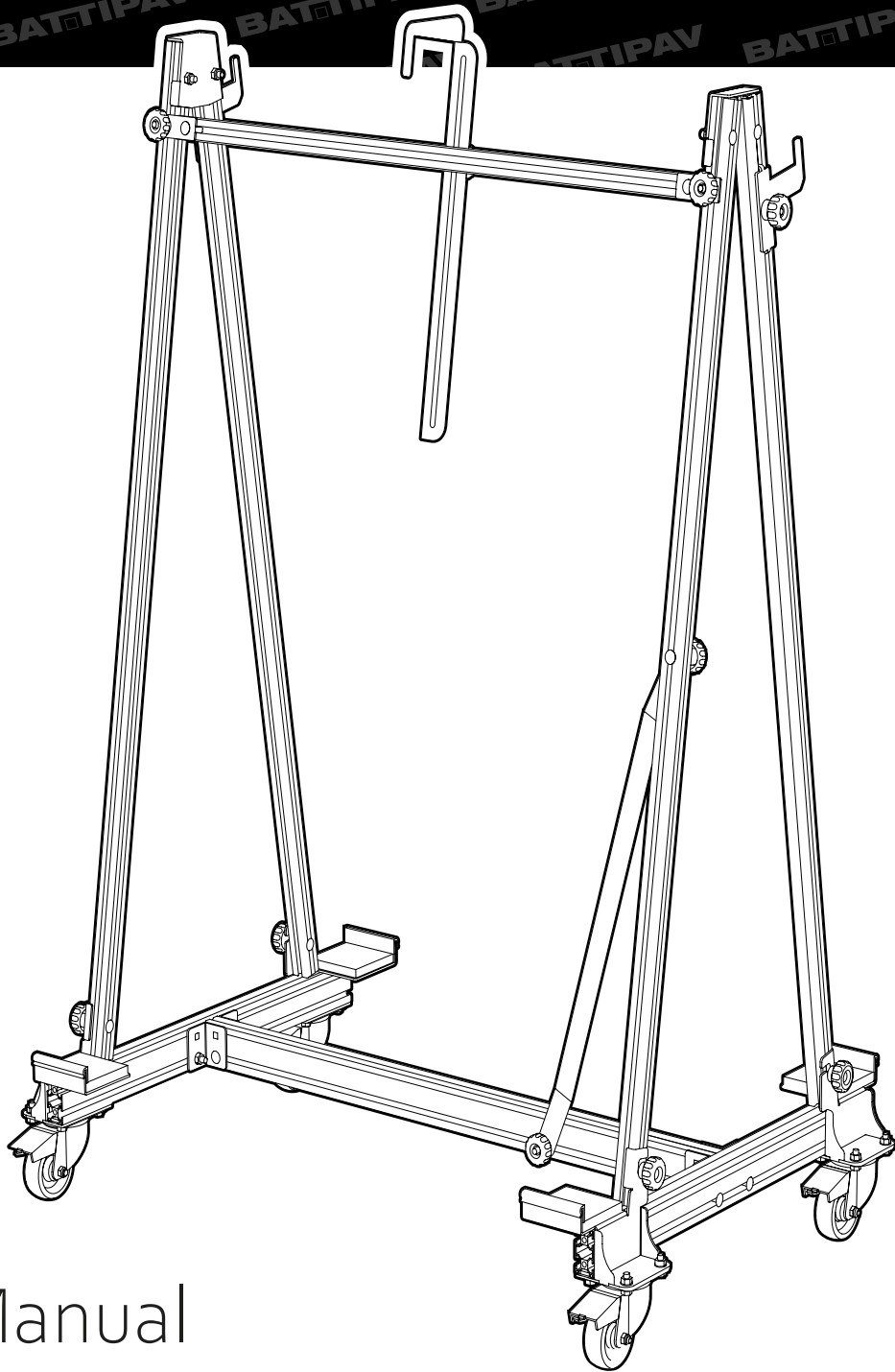

User Manual



**BATTIPAV™**

IT

**ISTRUZIONI PER L'USO DEL  
CARGO - CARRELLO PORTA LASTRE DI GRANDE FORMATO**

GB

**INSTRUCTIONS FOR USE OF THE  
CARGO - TROLLEY FOR LARGE FORMAT PLATES**

FR

**MANUEL D'INSTRUCTION POUR L'ÉLEVATEUR  
CARGO - CHARIOT POUR PLAQUES GRAND FORMAT**

DE

**BEDIENUNGSANLEITUNG FÜR DEN  
CARGO - WAGEN FÜR GROSSFORMATIGE PLATTEN**

ES

**MANUAL DE INSTRUCCIONES DEL  
CARGO - CARRO PARA PLANCHAS DE GRAN FORMATO**

NL

**GEBRUIKSAANWIJZING VOOR DE  
CARGO - TROLLEY VOOR GROOTFORMAAT PLATEN**



## ATTENZIONE - ATTENTION - ATTENTION - ACHTUNG - ATENCIÓN - ATTENTIE

Articoli destinati a personale specializzato nelle operazioni del settore delle costruzioni edili e di posa pavimentazione e rivestimenti di grande formato. • Items for specialised personnel in building construction and large-format flooring and wall-laying operations. • Articles destinés au personnel spécialisé dans la construction de bâtiments et les opérations de pose de revêtements de sol et de murs de grand format. • Artikel für Fachpersonal im Hochbau und für großformatige Bodenbelags- und Wandverlegearbeiten. • Artículos para personal especializado en construcción de edificios y operaciones de pavimentación y revestimiento de gran formato. • Items voor gespecialiseerd personeel in de bouw en grootformaat vloer- en wandlegwerkzaamheden

	INFORMAZIONI TECNICHE <sup>1</sup>		INFORMAZIONI IMBALLO <sup>2</sup>		
ARTICOLO <sup>3</sup>	MASSIMA DIMENSIONE TRASPORTABILE LASTRE <sup>4</sup>	MASSIMA CAPACITÀ DI CARICO <sup>5</sup>	 6	 7	 8
CARGO (Art. 11601)	1600x 3200 mm	250 KG	1320x758 x285 mm	6pz	1320x758 x1860 mm

### 1) Informazioni tecniche

Technical info - Informations techniques - Technische Informationen - Información técnica - Technische informatie

### 2) Informazioni Imballo

Packaging info - Informations sur l'emballage - Informationen zur Verpackung - Información sobre envases - Informatie over de verpakking

### 3) Articolo

Article - Article - Artikel - Artículo - Artikel

### 4) Massima dimensione trasportabile lastre

Maximum Transportable Slab Size - Taille maximale de la feuille transportable - Maximale Transportgröße der Bleche - Tamaño máximo transportable de las láminas - Maximale transporteerbare plaatgrootte

Max/Min bar length - Longueur de la barre Max/Min - Max/Min Stablänge - Longitud máx./mín. de la barra - Max/Min staaf lengte

### 5) Massima capacità di carico

Maximum Load Capacity - Capacité de charge maximale - Maximale Tragfähigkeit - Capacidad de carga máxima - Maximaal draagvermogen

### 6) Dimensioni imballo singolo

Single package dimensions - Dimensions de l'emballage unique - Abmessungen der Einzelverpackung - Dimensiones de un solo envase - Afmetingen enkelvoudige verpakking

### 7) Quantitativo pezzi per pallet

Quantité de pièces par palette - Anzahl der Stücke pro Palette - Cantidad de piezas por paleta - Aantal stuks per pallet

### 8) Dimensioni pallet completo

Dimensions de la palette complète - Vollständige Palettenabmessungen - Dimensiones del palé completo - Volledige palletafmetingen

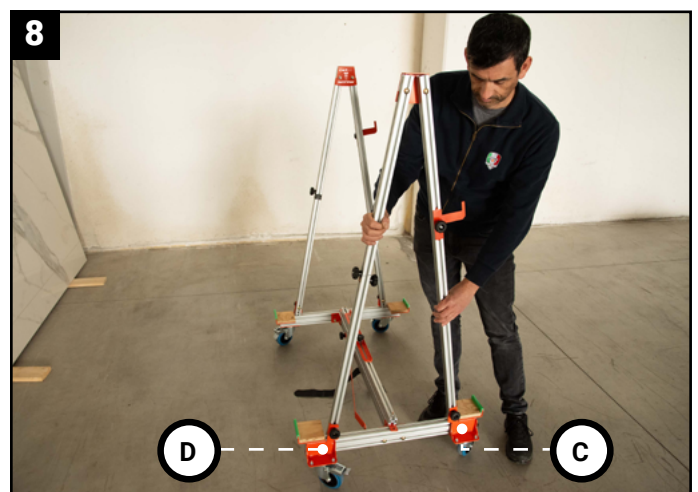
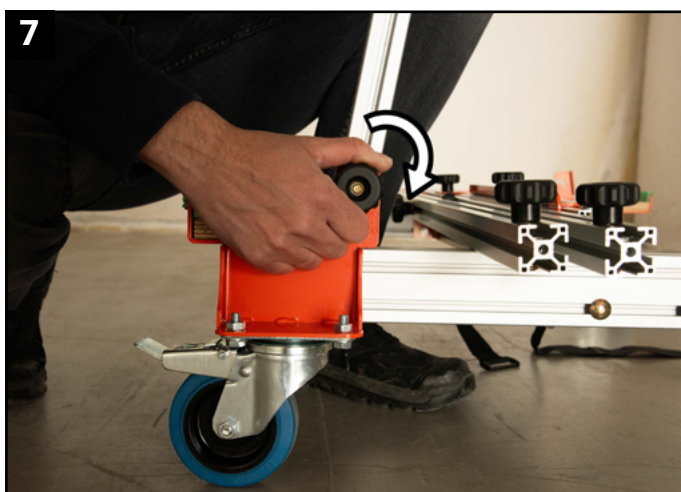
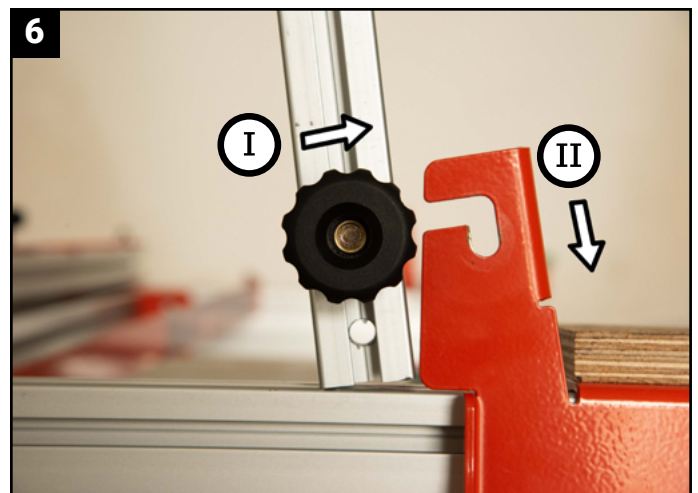
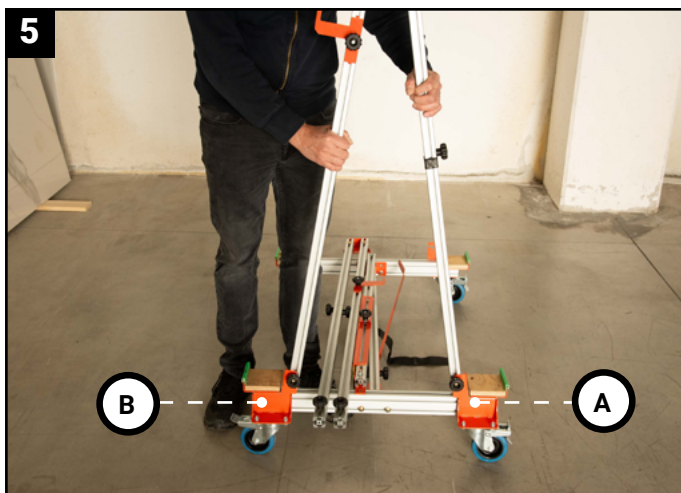
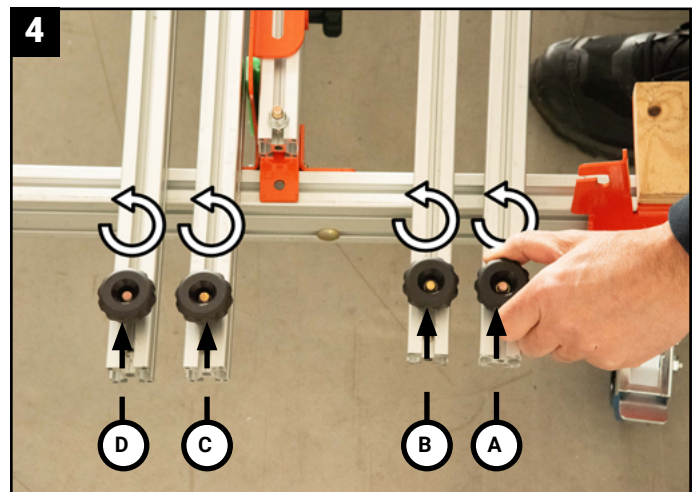
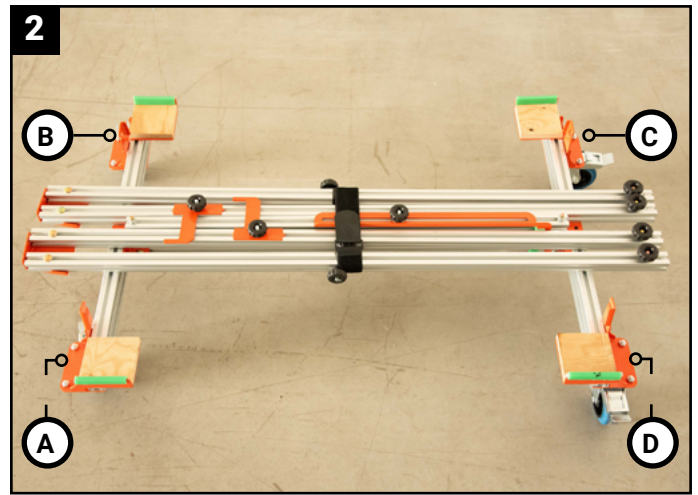
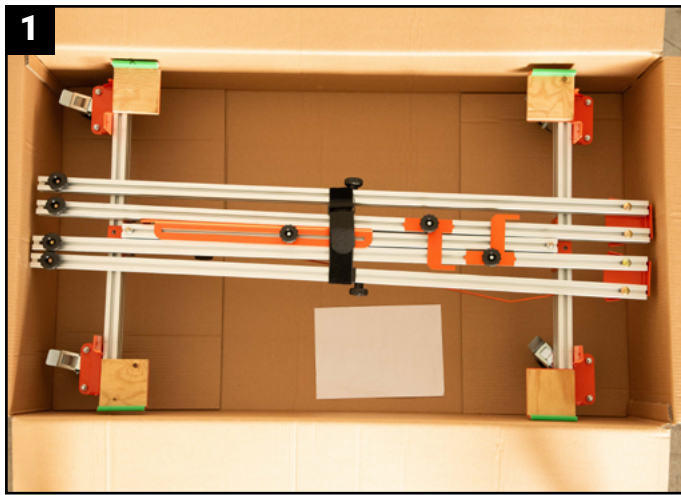

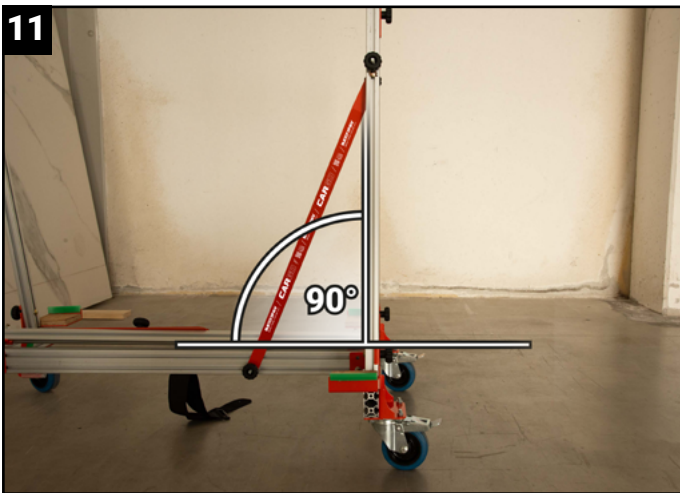
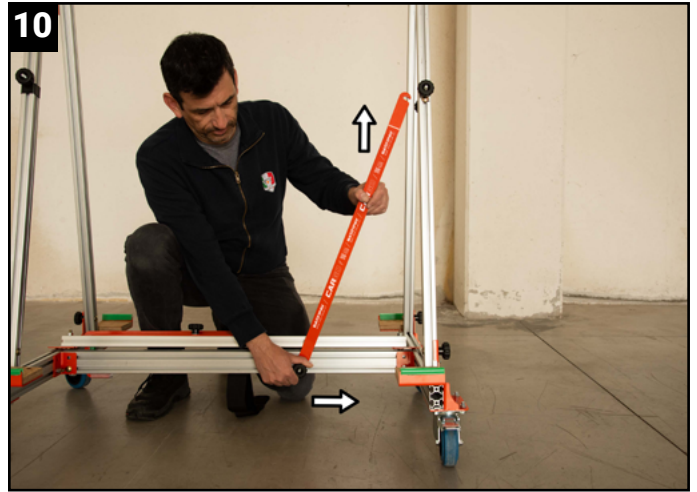
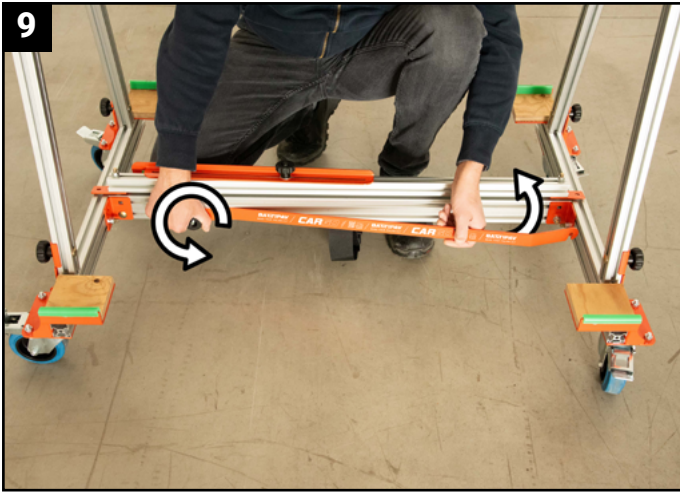

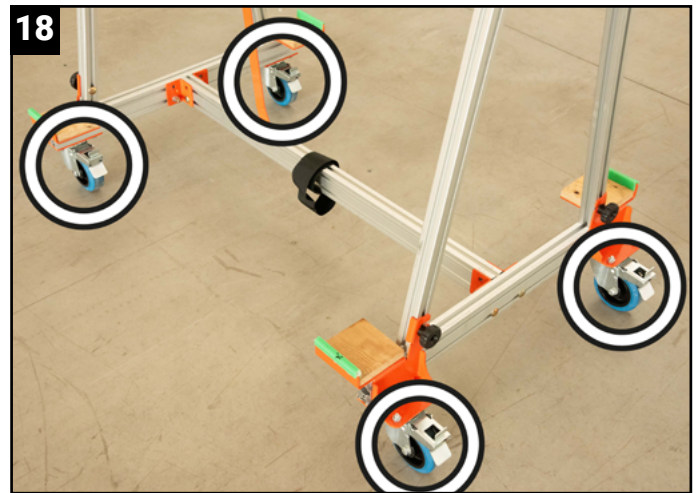
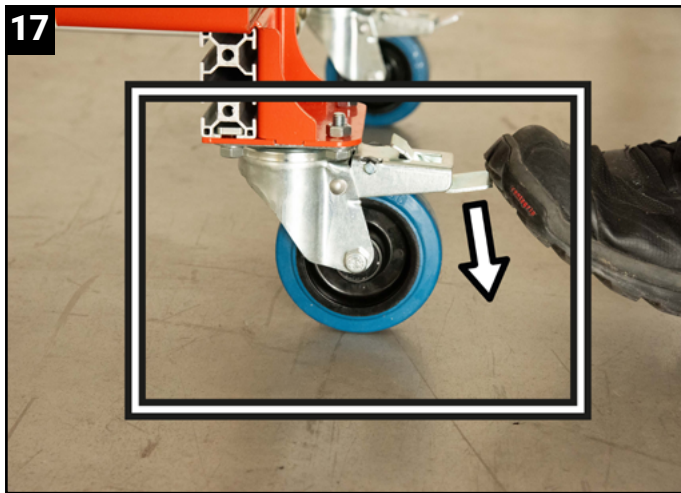

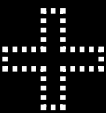
**CARGO** 

**AGILE LIGHT<sub>plus</sub>** /  
Art. 11006/1

**COMPACT LIGHT-PLUS** /  
Art. 11007

**AGILE LIGHT** /  
Art. 11002/1

**COMPACT LIGHT** /  
Art. 11008



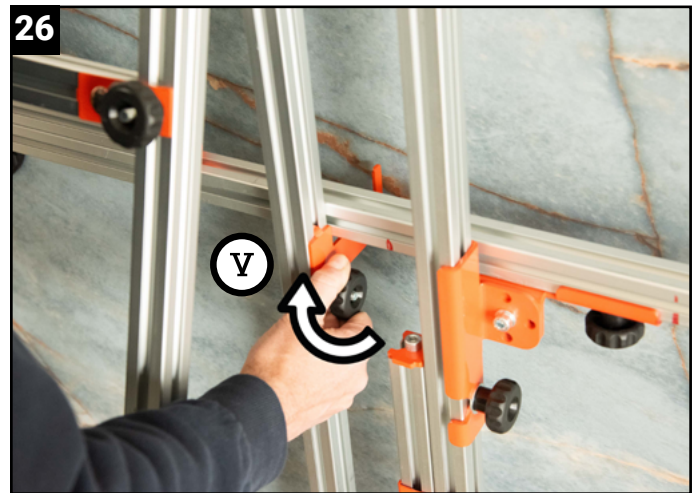
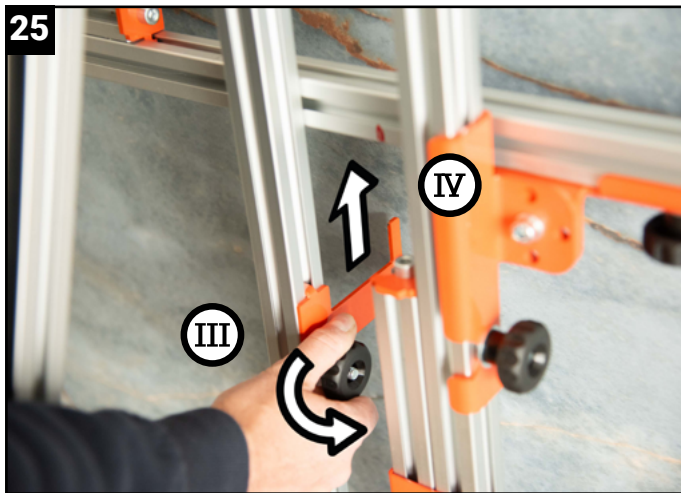
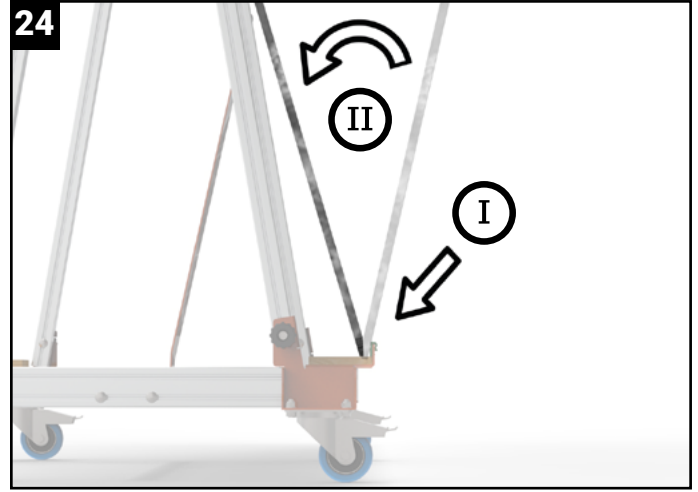

CHECK THE PRODUCT VIDEO  
ON OUR YOUTUBE CHANNEL  
BY CLICKING HERE



**BATTIPAV™**

