

Art. 11007

COMPACT LIGHT-PLUS

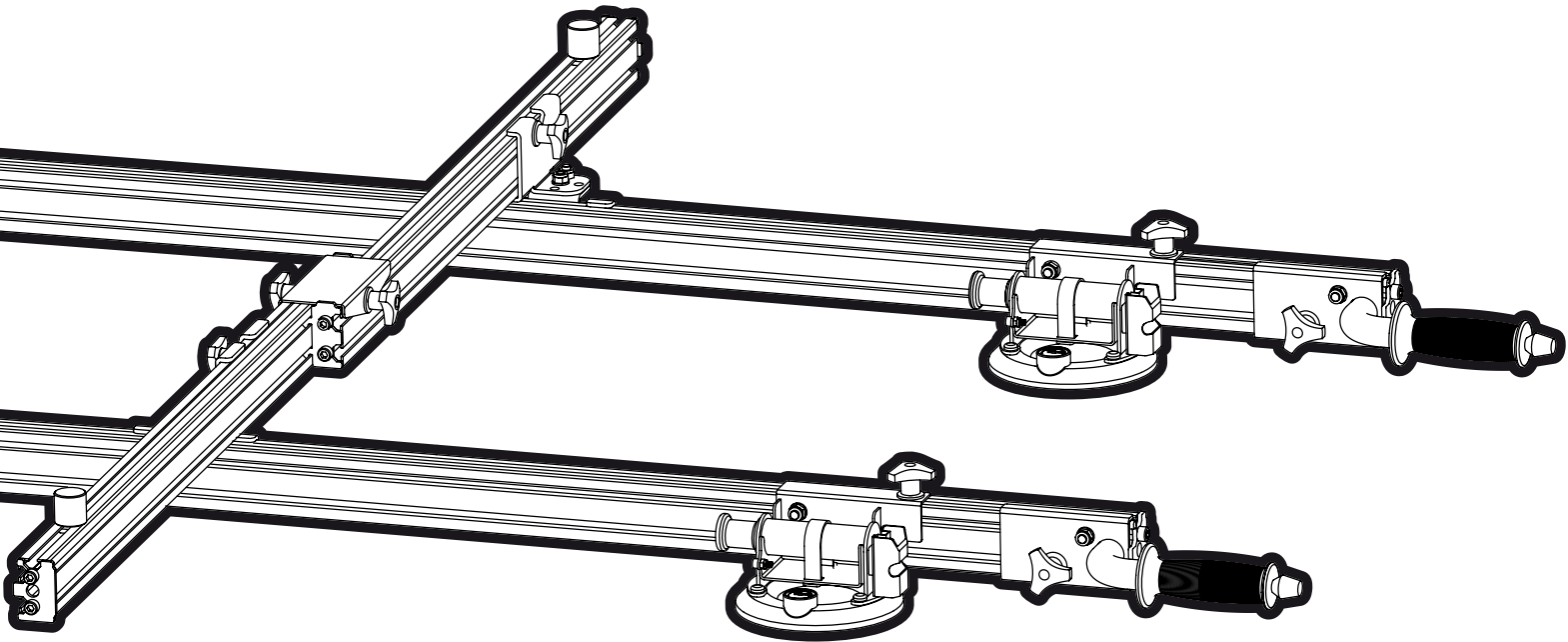

User Manual



BATTIPAVTM
COMPACT
LIGHT-PLUS

IT

**ISTRUZIONI PER L'USO DEL
COMPACT LIGHT PLUS SOLLEVATORE GRANDI FORMATI**

GB

**INSTRUCTIONS FOR USE OF THE
COMPACT LIGHT PLUS LARGE FORMAT LIFTER**

FR

**MANUEL D'INSTRUCTION POUR L'ÉLEVATEUR
COMPACT LIGHT PLUS LARGE FORMAT LIFTER**

DE

**BEDIENUNGSANLEITUNG FÜR DEN
COMPACT LIGHT PLUS GROSSFORMATHEFTER**

ES

**MANUAL DE INSTRUCCIONES DEL
COMPACT LIGHT PLUS ELEVADOR DE GRAN FORMATO**

NL

**GEBRUIKSAANWIJZING VOOR DE
COMPACT LIGHT PLUS GROOTFORMAAT HEFFER**



ATTENZIONE - ATTENTION - ATTENTION - ACHTUNG - ATENCIÓN - ATTENTIE

Articoli destinati a personale specializzato nelle operazioni del settore delle costruzioni edili e di posa pavimentazione e rivestimenti di grande formato. • Items for specialised personnel in building construction and large-format flooring and wall-laying operations. • Articles destinés au personnel spécialisé dans la construction de bâtiments et les opérations de pose de revêtements de sol et de murs de grand format. • Artikel für Fachpersonal im Hochbau und für großformatige Bodenbelags- und Wandverlegearbeiten. • Artículos para personal especializado en construcción de edificios y operaciones de pavimentación y revestimiento de gran formato. • Items voor gespecialiseerd personeel in de bouw en grootformaat vloer- en wandlegwerkzaamheden

	INFORMAZIONI TECNICHE ¹			INFORMAZIONI IMBALLO ²		
ARTICOLO ³	MASSIMA CAPACITÀ DI CARICO ⁴	MAX/MIN LUNGHEZZA BARRA ⁵	MAX/MIN LARGHEZZA BARRA ⁶	 7	 8	 9
COMPACT LIGHT PLUS (Art. 11007)	80 Kg	3300 mm - 20300 mm	1660 mm - 890 mm	1900x615x 205 mm	8pz	1950x720 x1790mm

1) Informazioni tecniche

Technical info - Informations techniques - Technische Informationen - Información técnica - Technische informatie

2) Informazioni Imballo

Packaging info - Informations sur l'emballage - Informationen zur Verpackung - Información sobre envases - Informatie over de verpakking

3) Articolo

Article - Article - Artikel - Artículo - Artikel

4) Massima capacità di carico

Maximum load capacity - Capacité de charge maximale - Maximale Tragfähigkeit - Capacidad de carga máxima - Maximaal draagvermogen

5) Max/Min lunghezza barra

Max/Min bar length - Longueur de la barre Max/Min - Max/Min Stablänge - Longitud máx./mín. de la barra - Max/Min staaflengte

6) Max/Min larghezza barra

Max/Min bar width - Largeur de barre Max/Min - Max/Min Balkenbreite - Anchura máx./min. de la barra - Max./min. breedte van balk

7) Dimensioni imballo singolo

Single package dimensions - Dimensions de l'emballage unique - Abmessungen der Einzelverpackung - Dimensiones de un solo envase - Afmetingen enkelvoudige verpakking

8) Quantitativo pezzi per pallet

Quantité de pièces par palette - Anzahl der Stücke pro Palette - Cantidad de piezas por paleta - Aantal stuks per pallet

9) Dimensioni pallet completo

Dimensions de la palette complète - Vollständige Palettenabmessungen - Dimensiones del palé completo - Volledige palletafmetingen

Art. 11007

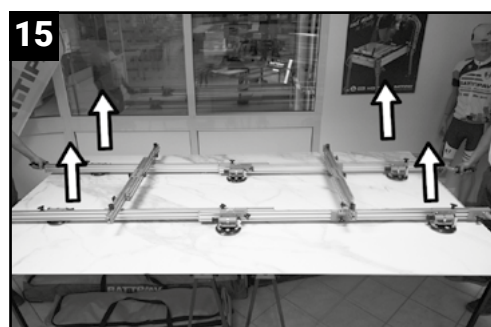
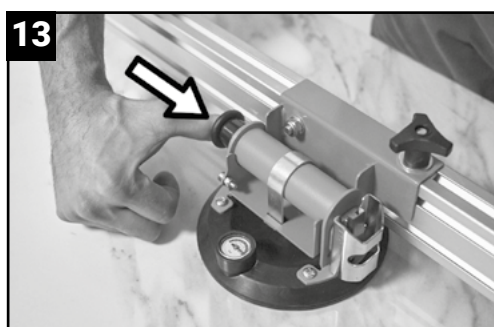
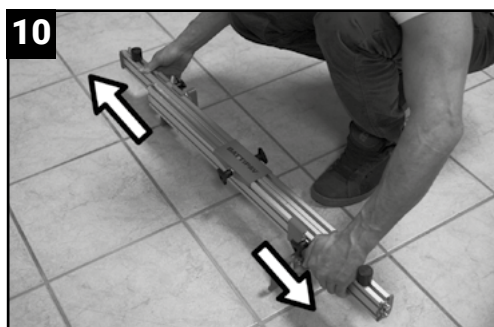
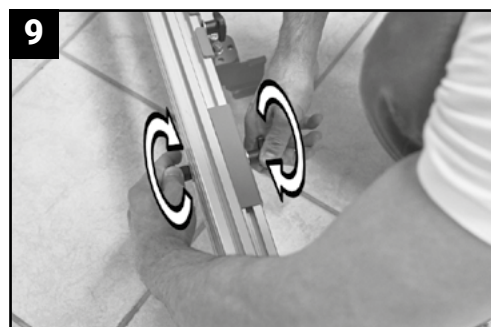
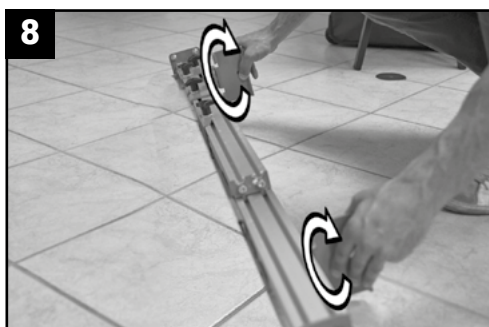
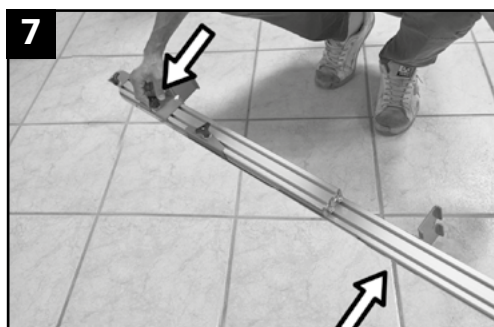
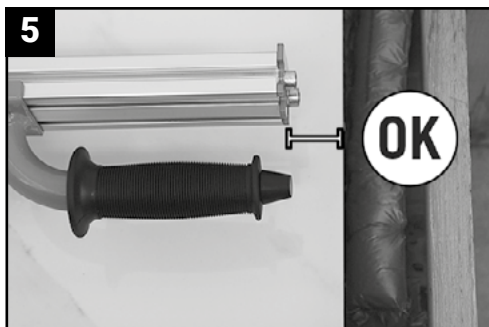
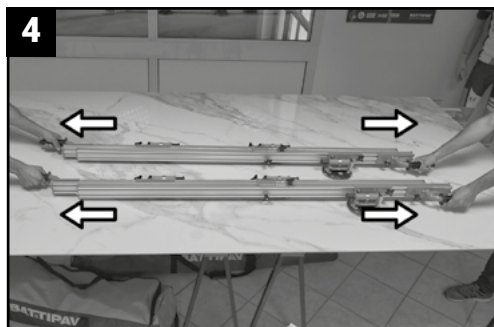

Art. 11007

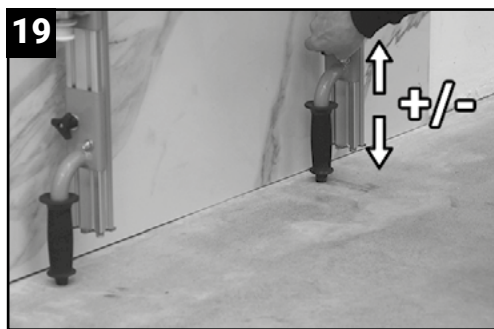
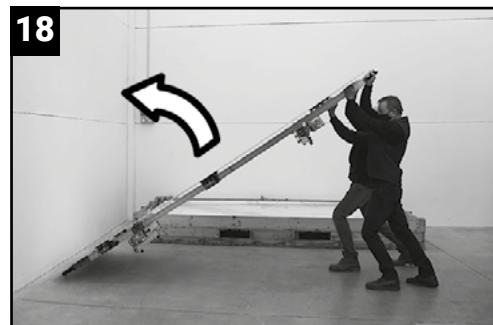
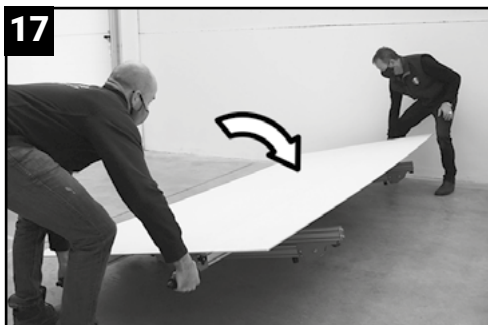

CHECK THE PRODUCT VIDEO
CLICK HERE



BATTIPAVTM

